



Revolution Frontier™
From Innovation
to Outcomes...
Everyday





Surpass the everyday potential of CT

One of the biggest challenges with today's CT is that conventional systems often lack the fine detail and tissue composition needed to clearly characterize a disease. This puts you in the position of having to order additional follow-up tests to complete a diagnosis.

It's time for CT to evolve beyond anatomy to function. From detailed images of inner structures to an understanding of what those structures are made of. It's time for both high sensitivity and high specificity.

Introducing Revolution Frontier. Built to push the boundaries of what you expect from your CT, Revolution Frontier includes an all-new imaging chain, a streamlined spectral imaging experience and a robust toolkit of imaging modes right at your fingertips. It takes CT innovation to a whole new level of everyday capability.



Detailed vasculature to identify a right femoral artery

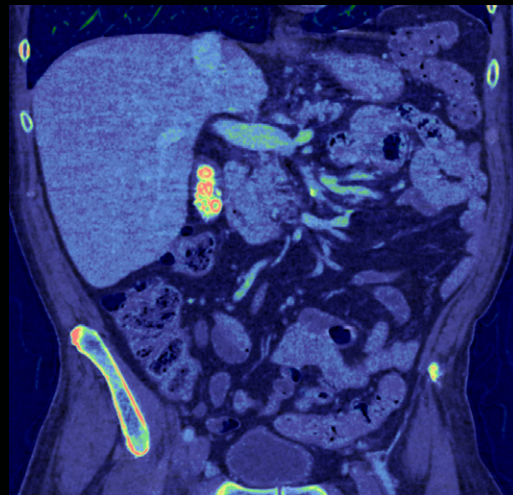

GSI Pro to identify the chemical composition of gallstones, getting the patient to the right treatment path sooner

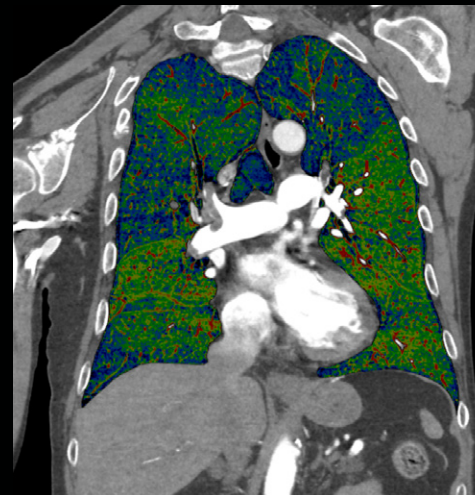

GSI Pro goes beyond anatomy to visualize perfusion defects in the presence of pulmonary emboli

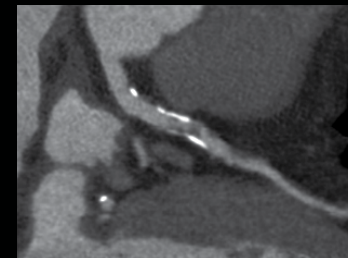

Calcium and stent blooming is reduced, allowing for a more confident diagnosis



Exquisite visualization of bony trabecular pattern

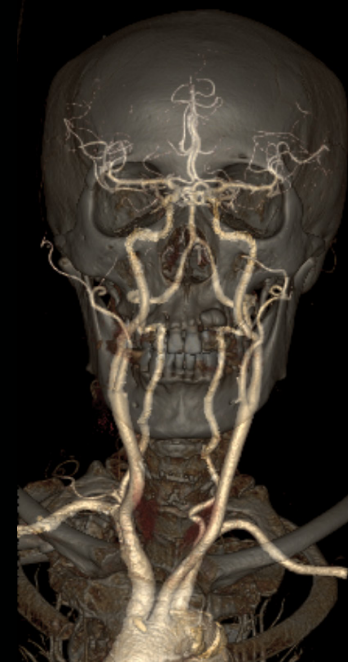

High-resolution imaging for improved segmentation and tracking of vessels



Innovation

Innovation along the entire imaging chain

Our Revolution™ family of CT systems is known for its breakthrough imaging technology. Revolution Frontier was designed to take this technology to the next level for your high-performance clinical needs.

Its all-new imaging chain features the powerful Performix™ HD Plus. This liquid metal bearing X-ray tube significantly reduces the wear that is typical with conventional ball bearing technology. The result is shorter tube warm-up times between scans as well as up to two times longer tube life.

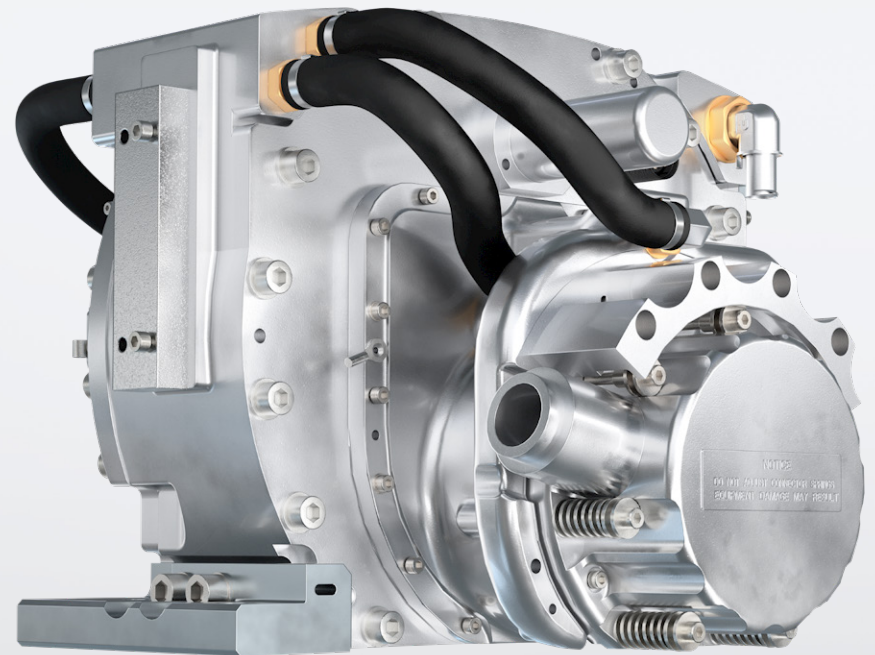

It also includes our Gemstone™ Clarity detector modules. Built with the proven Gemstone material known for its high primary speed and low afterglow, the miniaturized design of each detector module shortens the distance information has to travel. For the most challenging cases, you can easily implement High Definition mode to further improve spatial resolution to 0.23 mm.

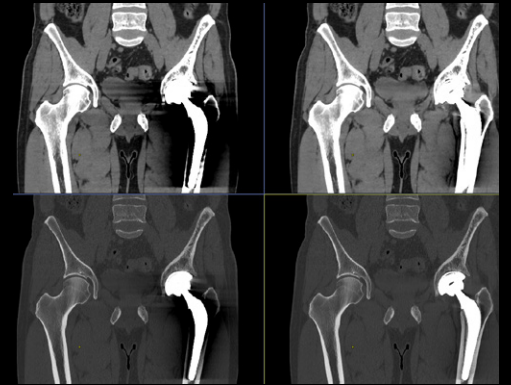
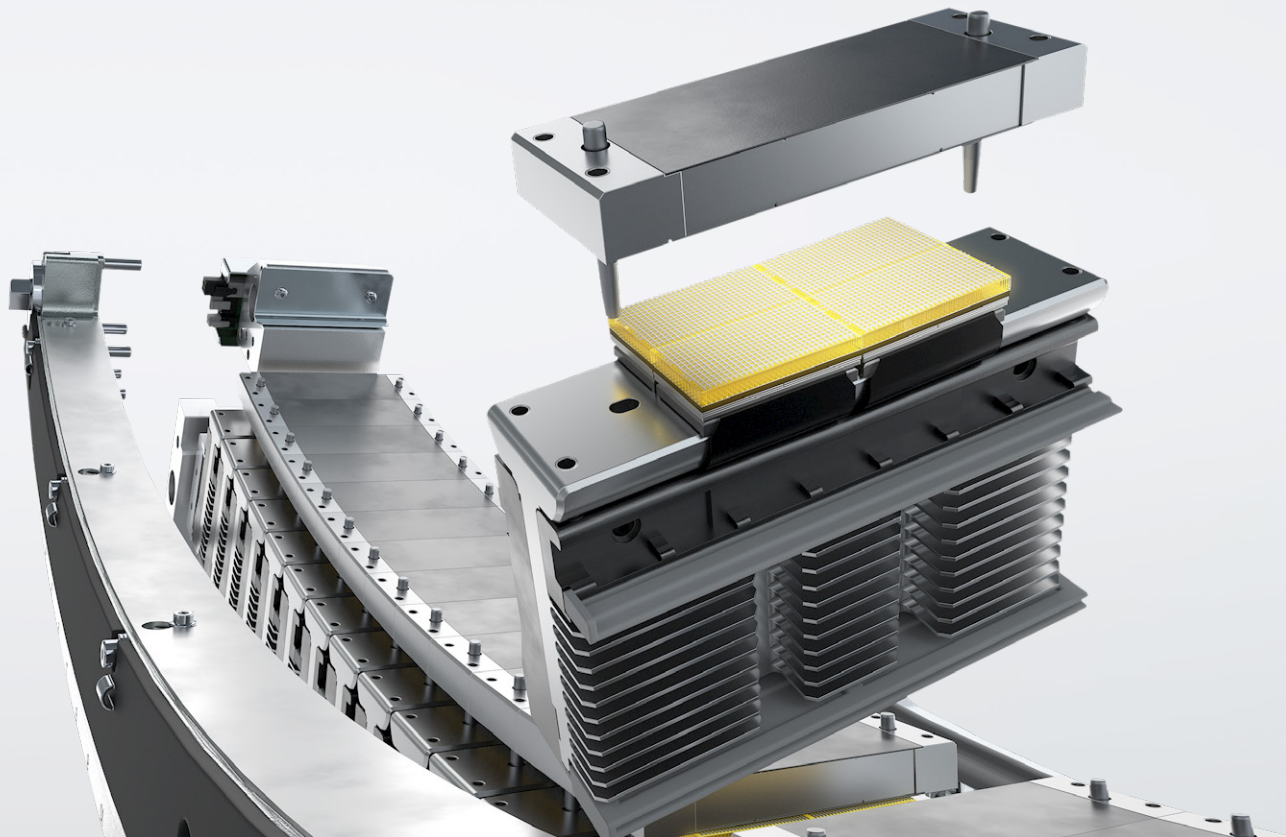

Significant reduction in electronic noise

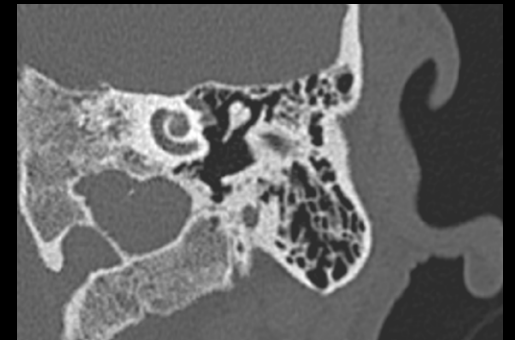

Impressive spatial resolution

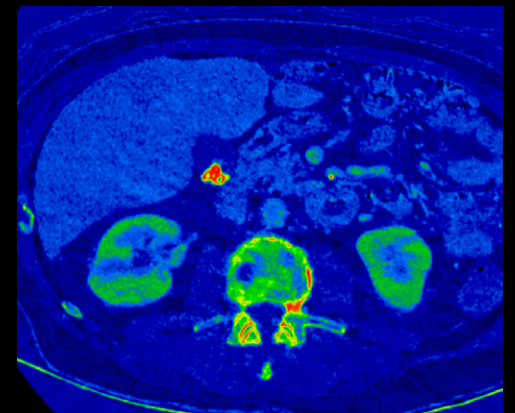

Routine spectral imaging capabilities

- 80 kV
- 140 kV

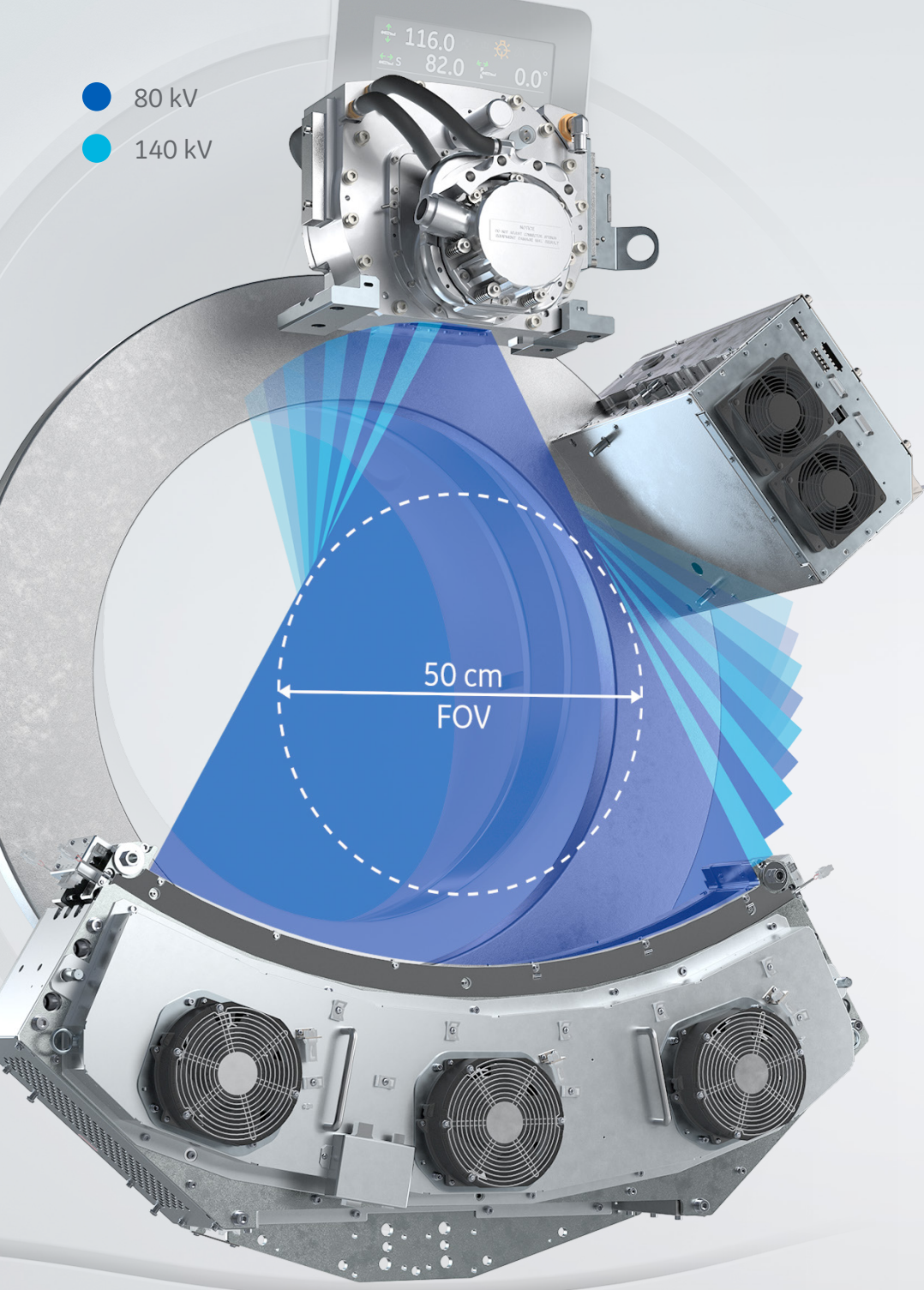

Outcomes

The spectral CT you've been waiting for

New technology, like spectral imaging, can be difficult to adopt if it has limited utility or doesn't fit into the processes you already have in place. We addressed these challenges with Gemstone Spectral Imaging (GSI) Pro.

GSI is our proven spectral imaging application. It uses our Gemstone detector and rapid kV switching to acquire dual energy samples from a single source. With GSI Pro, we improved the GSI experience by allowing it to seamlessly integrate with AW applications. We also significantly reduced reconstruction times with a breakthrough in spectral CT technology that effortlessly processes gigabytes of data at a time.

0.25 ms

kV switching rate

4 cm

of spectral data

50 cm

material
decomposition
over the full FOV

Over
165

times faster
temporal registration

These improvements to spectral imaging technology make the clinical benefits of GSI routinely accessible. It gives you the freedom to explore the benefits of up to a 50 percent improvement in beam-hardening artifacts and non-contrast-like images that subtract detected iodine.

Beyond that, by incorporating the latest in iterative reconstruction technology, ASiR-V™,¹ GSI Pro also enables dose neutrality, lower image noise and improved low-contrast detectability for patients of any size.



Reduce unnecessary follow-ups due to inconclusive results



Reduce non-interpretable scans due to metal artifact

Accurate kidney stone characterization



Kidney stone identified with ROI placed

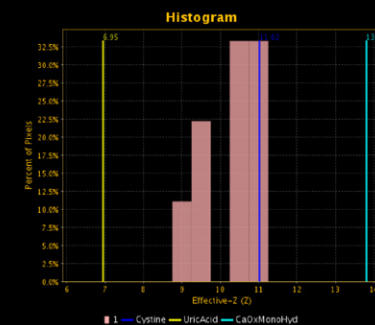

Histogram suggesting effective-Z value correlating to cystine

Improved liver lesion visualization

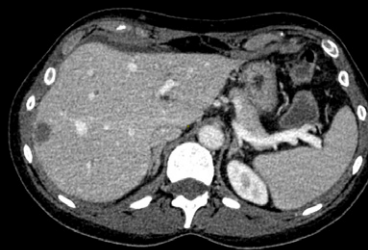

40 keV

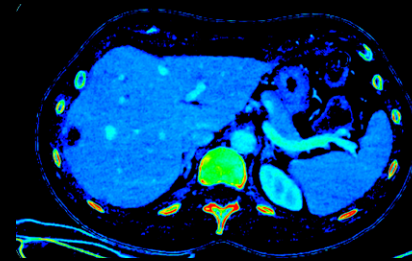

Iodine map

Optimize iodinated contrast



"I was absolutely stunned to see through the metal artifact and actually see the bladder in a patient with bilateral hip replacement."

- Dr. K. Conner, CT Section Chief, Intermountain Healthcare, USA

50 cm FOV

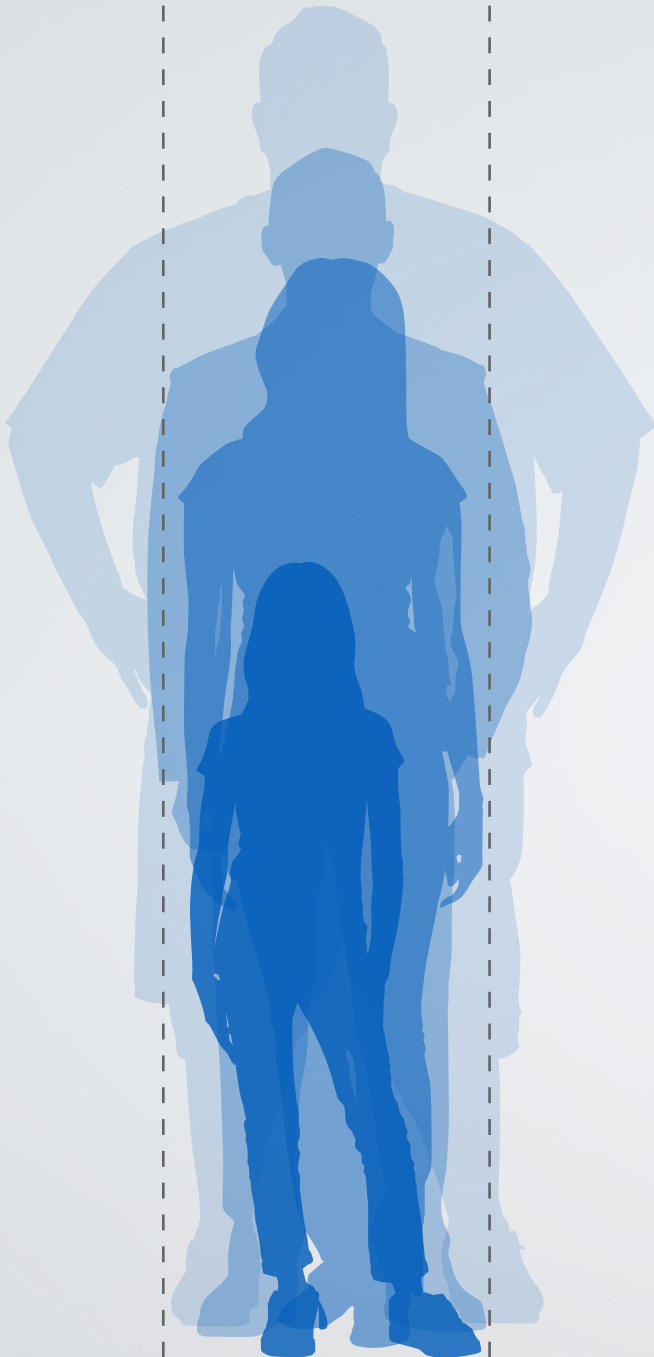

Everyday

Ready to adapt to every patient

Revolution Frontier was designed around the principle that no two examinations are ever the same. To do this, we made sure you can address individual clinical needs by moving seamlessly from one scan mode to the next. You can image with a stunning 0.23 mm spatial resolution and then switch to rapid kV switching for full 50 cm FOV spectral imaging of the entire body. Ensure low dose across all exams with ASiR-V¹ and use 0.35 second rotation routinely.

0.35

second rotation speed

Up to

82%

less radiation dose with ASiR-V¹



0.35 second rotation for minimal breath hold and less motion artifact

"We are getting fantastic images at low dose in routine scanning with ASiR-V."

- Dr. K. Conner, CT Section Chief, Intermountain Healthcare, USA

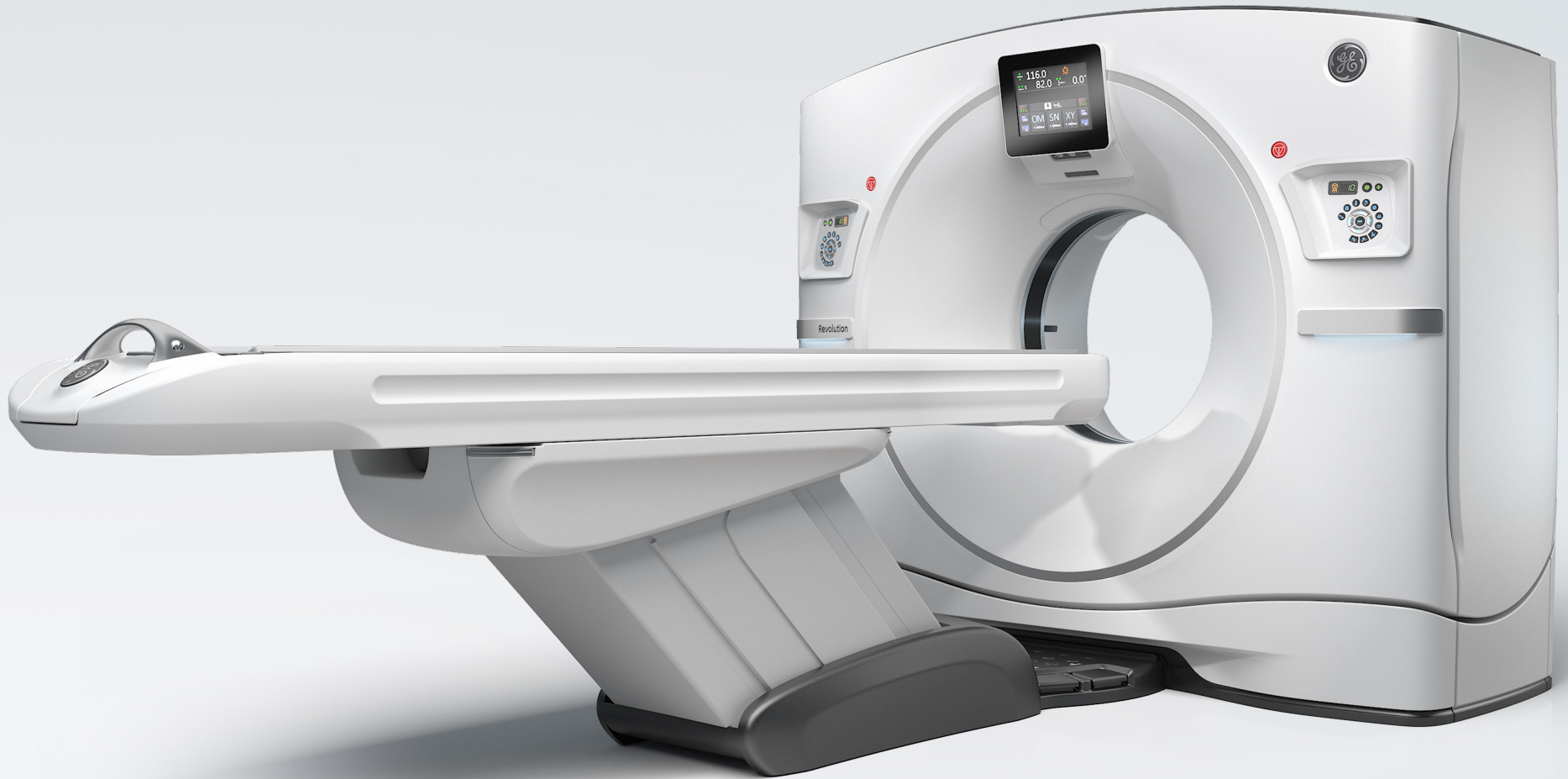

This level of clinical versatility is supported by key service solutions to keep your CT up and running. As an original equipment manufacturer, we know more about our systems than anyone else. We offer a complete package of predictive and proactive service solutions to ensure your system stays at peak performance.



Original
equipment
manufacturer



Predictive and
proactive service



Reduce unplanned
X-ray tube replacement
downtime

Neuro Imaging

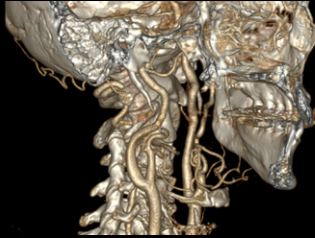

Excellent neuro and carotid detail with no impact of artifacts from dental work by using Smart MAR

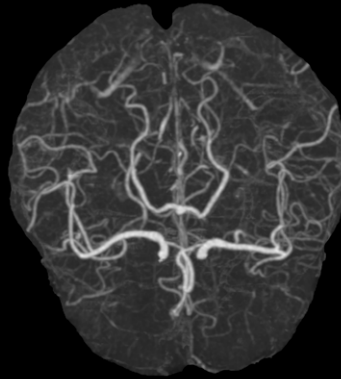

Robust opacification and visualization of even the smallest vessels in the brain

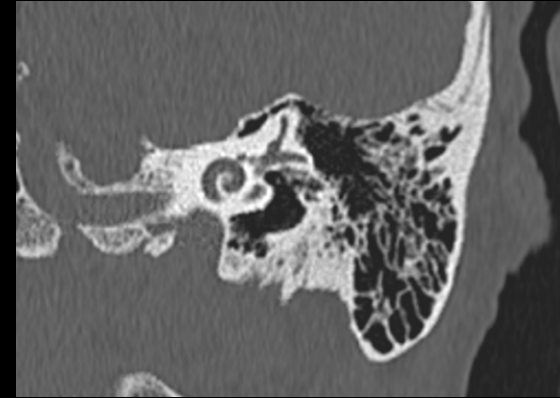

High-resolution imaging for visualization of the smallest details

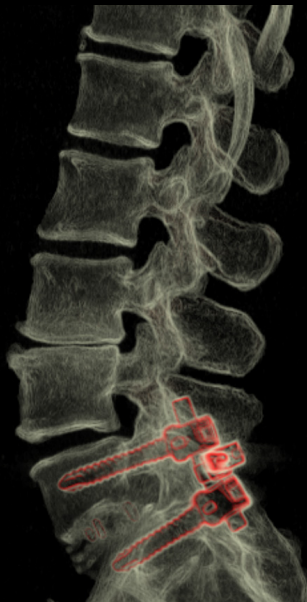

Post-surgical follow-up to assess anatomical integrity



Optimal contrast-to-noise and low-contrast detectability with GSI brain

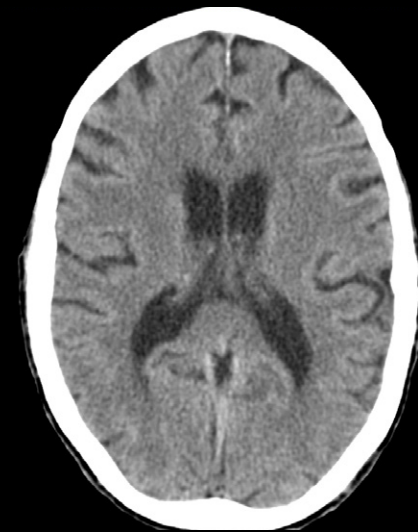

Clear delineation of grey/white matter through improved low-contrast detectability

Cardiothoracic Imaging



0.35 second acquisition TAVR

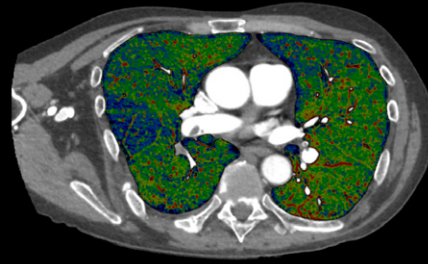

Pulmonary embolism using GSI Pro to visualize perfusion defects with less iodine load



Diagnostic coronary CT Angiography of patient with BMI of 40

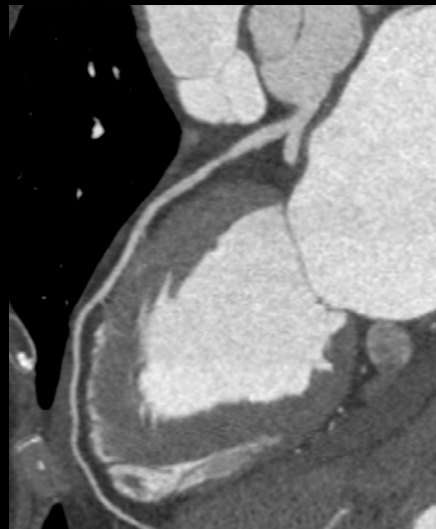

Curved LAD without motion artifact by using SnapShot™ Freeze²

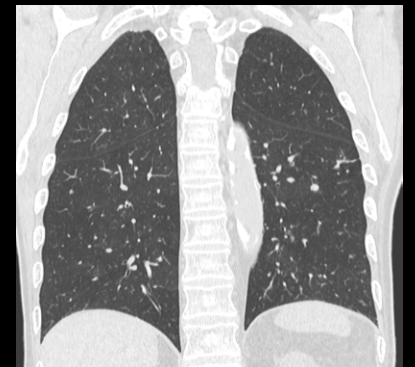
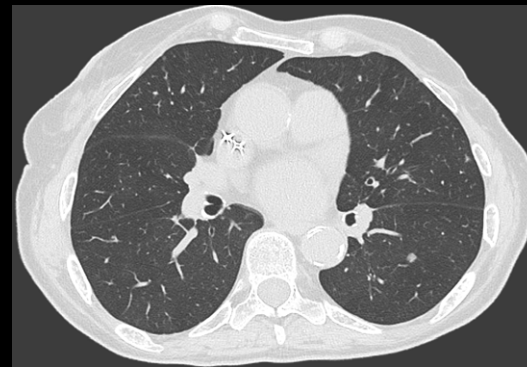

High-resolution lung imaging for oncology follow-up

Abdominal and Pelvic Imaging

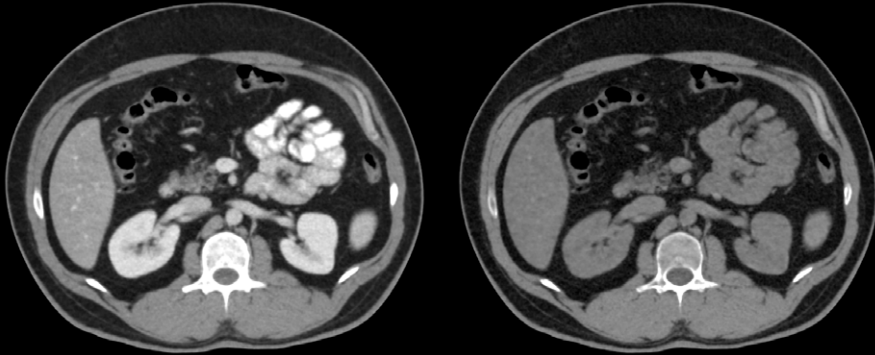

Virtual Unenhanced (VUE) image (right) from a GSI abdomen with contrast and large FOV (47 cm)



Low-dose abdomen pelvis using ASiR-V, DLP 185

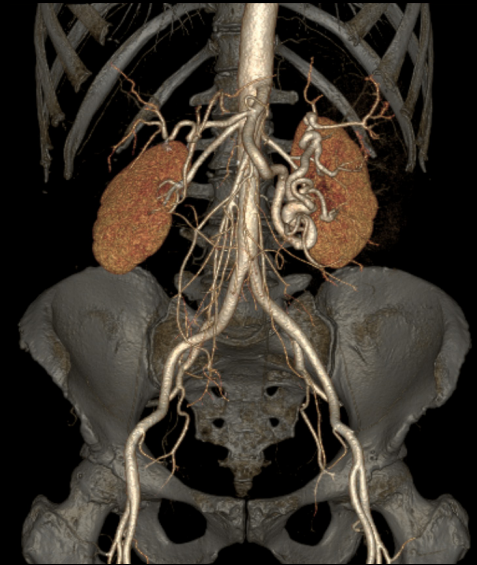

Stunning vasculature detail even in tortuous vessels

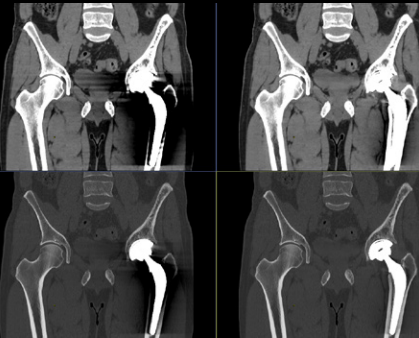

GSI MAR to minimize metal artifacts in order to see soft tissue around prosthetics

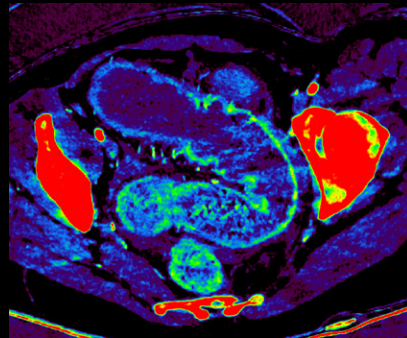

GSI Pro of colon with iodine color overlay to demonstrate hypoperfusion

"In our department, we use spectral imaging for 90 percent of patients with acute abdominal conditions."

Dr. M. Zins, St. Joseph Hospital Group, Paris, France

Extremity Imaging

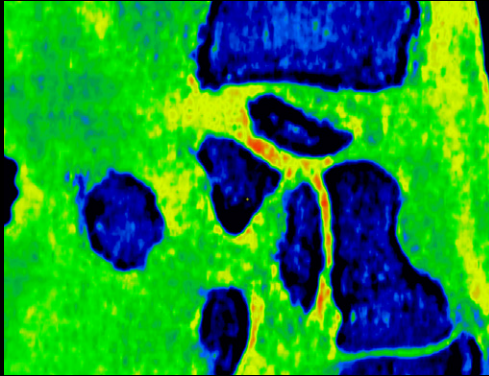

GSI Pro to confirm the lack of bone edema post-fracture

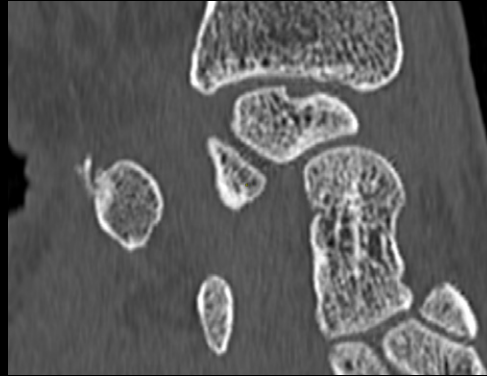

High-resolution imaging to quickly identify a tibial plateau fracture with beautiful trabecular detail



Smart MAR coupled with high-resolution imaging to reduce metal artifact while maintaining bony detail



Specifications

Everything you expect from CT. And more.

Our entire Revolution brand of CT systems is built out of our passion to enable you with extraordinary technologies that will allow you to reach the right diagnosis, effortlessly. Revolution Frontier is no exception to this mission. With new features and capabilities that allow you to image more patients, in new ways, Revolution Frontier is a phenomenal clinical tool for pushing the boundaries of CT.

“This scanner can help us further build our chronic thromboembolic pulmonary hypertension treatment clinics by looking at perfusion in addition to filling defects. Also, we expect it will help our urology partners in identifying the composition of renal stones. We are also excited to use the new system in planning complex pancreatic cancer treatment, as it appears we can see the lesions as well as liver metastases better than without spectral imaging.”

- Dr. K. Conner, CT Section Chief, Intermountain Healthcare, USA

Gantry

Bore size	70 cm
Gantry tilt	+/- 30 degrees
SFOV (single energy mode)	50 cm
Rotation speed	Up to 0.35 seconds

Tube and Generator

Tube	Performix HD Plus
Maximum power	100 kW
Tube current	10 to 835 mA, in mA increments
Tube voltage	80, 100, 120, 140
Heat storage	8 MHU (equivalent with ASiR-V 37.4 MHU)

Reconstruction

Iterative reconstruction	ASiR-V
Reconstruction time	Up to 70 fps

Gemstone Spectral Imaging

Technique	Fast kVp switching (80/140 kVp)
SFOV	50 cm
Temporal registration	Up to 0.25 ms
Monochromatic energy range	40 to 140 keV

Detector and DAS

Detector material	Gemstone Clarity
Detection efficiency (@120 kVp)	98%
Views per rotation	Up to 2,496 views per rotation
Spatial resolution	21.4 lp/cm

Table

Table specification	VT1700	VT2000x
Table load capacity	227 kg / 500 lbs	306 kg / 675 lbs
Horizontal range	1700 mm	2000 mm
Vertical range	430 to 991 mm	525 to 991 mm



GE Healthcare provides transformational medical technologies and services to meet the demand for increased access, enhanced quality and more affordable healthcare around the world. GE (NYSE: GE) works on things that matter – great people and technologies taking on tough challenges.

From medical imaging, software & IT, patient monitoring and diagnostics to drug discovery, biopharmaceutical manufacturing technologies and performance improvement solutions, GE Healthcare helps medical professionals deliver great healthcare to their patients.

Imagination at work

© 2018 General Electric Company – All rights reserved.

GE Healthcare reserves the right to make changes in specifications and features shown herein, or discontinue the product described at any time without notice or obligation. Contact your GE Healthcare representative for the most current information. Revolution Frontier, Revolution, Performix, Gemstone, ASiR-V, SnapShot, Imagination at work, GE and the GE Monogram are trademarks of General Electric Company. GE Healthcare, a division of General Electric Company. GE Medical Systems, Inc., doing business as GE Healthcare.

JB56757XX

¹In clinical practice, the use of ASiR-V may reduce CT patient dose depending on the clinical task, patient size, anatomical location and clinical practice. A consultation with a radiologist and a physicist should be made to determine the appropriate dose to obtain diagnostic image quality for the particular clinical task.

²A 6x improvement of motion-blur reduction while maintaining high spatial resolution is demonstrated in cardiac phantom testing. The reduction in motion artifacts is comparable to a 0.058 s Equivalent Gantry Rotation Speed with effective temporal resolution of 29 msec, as demonstrated in mathematical phantom testing.